

Article number: 2030100M20200A2U

Description: E+G levelling foot
GN 30-100-M20-200-A2-U

Note: U Without nut, Hexagon socket at the top, Wrench flat at the bottom

Measures

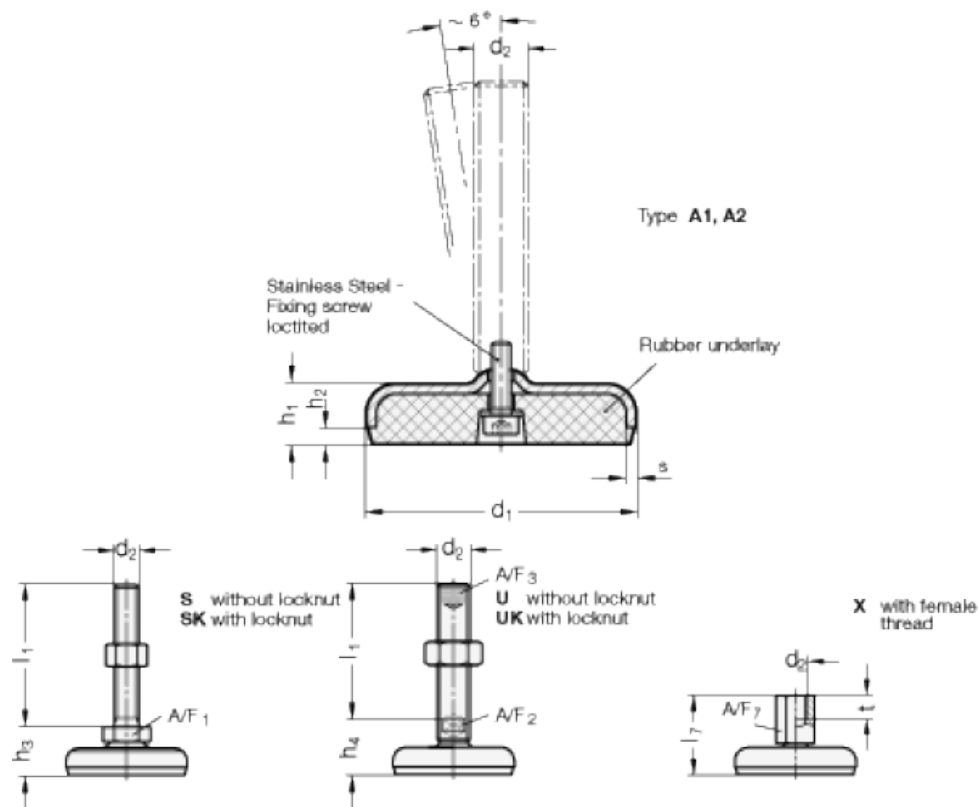

A/F2 = 15
A/F3 = 10
d1 = 100
d2 = M20
h1 = 20
h2 = 6
h4 = 35
l1 = 200

s = 3